

N3 package: 1200V 75A IGBT PIM module

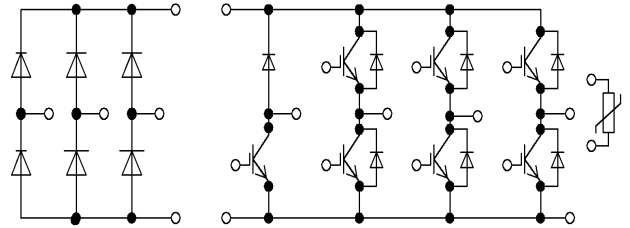

等效电路图

Equivalent Circuit Schematic

Features:

- 1200V 75A, $V_{CE(sat)} = 1.45V @ 25^{\circ}C$
- MPT Gate Technology
- Low Losses
- High RBSOA capability
- Low reverse-recovery losses

产品特性:

- 1200V 75A, $V_{CE(sat)} = 1.45V @ 25^{\circ}C$
- 微沟槽栅/场终止技术
- 低损耗
- 高 RBSOA 能力
- 低反向恢复损耗

Typical Applications:

- Motor Drives
- Servo Drives

典型应用:

- 电机驱动
- 伺服驱动

IGBT, Inverter / IGBT, 逆变部分

Maximum Rated Values / 最大标称数

Collector-emitter Voltage 集电极-发射极电压	$T_{vj}=25^{\circ}\text{C}$	V_{CES}	1200	V
Continuous DC collector current 集电极连续直流电流		$I_{C\text{ nom}}$	75	A
	$T_C=100^{\circ}\text{C}, T_{vj\text{ max}}=175^{\circ}\text{C}$	I_C	95	A
Repetitive Peak collector current 集电极可重复峰值电流	$I_{CRM}=2 \times I_{C\text{ nom}}$	I_{CRM}	150	A
Gate-emitter peak voltage 门极-发射极峰值电压		V_{GES}	± 20	V

Characteristic Values / 性能参数

			min.	typ.	max.		
Collector-emitter saturation Voltage ¹⁾ 集电极-发射极饱和压降	$I_C=75\text{A}, V_{GE}=15\text{V}$	$T_{vj}=25^{\circ}\text{C}$	V_{CESat}	1.45	1.80	V	
	$I_C=75\text{A}, V_{GE}=15\text{V}$	$T_{vj}=125^{\circ}\text{C}$		1.65			
	$I_C=75\text{A}, V_{GE}=15\text{V}$	$T_{vj}=175^{\circ}\text{C}$		1.72			
Gate Threshold Voltage 门极阈值电压	$V_{CE}=V_{GE}, I_C=1.5\text{mA},$	$T_{vj}=25^{\circ}\text{C}$	V_{GEth}	5.0	6.0	7.0	V
Gate Charge 门极电荷	$V_{GE}=-8\text{V}/15\text{V}, V_{CE}=600\text{V} T_{vj}=25^{\circ}\text{C}$		Q_G		0.67		μC
Internal Gate Resistor 内置门极电阻	$T_{vj}=25^{\circ}\text{C}$		R_{Gint}		1.65		Ω
Input Capacitance 输入电容	$V_{CE}=25\text{V}, V_{GE}=0\text{V}$ $f=100\text{KHz}$		C_{ies}		16.5		nF
Reverse Transfer Capacitance 反向传输电容			C_{res}		0.05		nF
Collector-emitter Cutoff Current 集电极-发射极关断漏电流	$V_{CE}=1200\text{V}, V_{GE}=0\text{V},$	$T_{vj}=25^{\circ}\text{C}$	I_{CES}			200	μA
Gate-emitter Leakage Current 门极-发射极漏电流	$V_{CE}=0\text{V}, V_{GE}=20\text{V},$	$T_{vj}=25^{\circ}\text{C}$	I_{GES}			200	nA
Turn-on Delay Time, Inductive Load 开通延迟时间, 感性负载	$I_C=75\text{A}, V_{CE}=600\text{V}$ $V_{GE}=\pm 15\text{V}$ $R_{Gon}=6.0\Omega$	$T_{vj}=25^{\circ}\text{C}$	t_{don}		90	ns	
		$T_{vj}=125^{\circ}\text{C}$			100		
		$T_{vj}=175^{\circ}\text{C}$			100		
Rise Time, Inductive Load 上升时间, 感性负载	$I_C=75\text{A}, V_{CE}=600\text{V}$ $V_{GE}=\pm 15\text{V}$ $R_{Gon}=6.0\Omega$	$T_{vj}=25^{\circ}\text{C}$	t_r		35	ns	
		$T_{vj}=125^{\circ}\text{C}$			50		
		$T_{vj}=175^{\circ}\text{C}$			50		
Turn-off Delay Time, Inductive Load 关断延迟时间, 感性负载	$I_C=75\text{A}, V_{CE}=600\text{V}$ $V_{GE}=\pm 15\text{V}$ $R_{Goff}=5.0\Omega$	$T_{vj}=25^{\circ}\text{C}$	t_{doff}		235	ns	
		$T_{vj}=125^{\circ}\text{C}$			300		
		$T_{vj}=175^{\circ}\text{C}$			300		
Fall Time, Inductive Load 下降时间, 感性负载	$I_C=75\text{A}, V_{CE}=600\text{V}$ $V_{GE}=\pm 15\text{V}$ $R_{Goff}=5.0\Omega$	$T_{vj}=25^{\circ}\text{C}$	t_f		115	ns	
		$T_{vj}=125^{\circ}\text{C}$			175		
		$T_{vj}=175^{\circ}\text{C}$			230		
Turn-on energy loss per pulse 开通损耗	$I_C=75\text{A}, V_{CE}=600\text{V},$ $V_{GE}=\pm 15\text{V}$ $R_{Gon}=6.0\Omega, di/dt =$ $1200\text{ A}/\mu\text{s} (T_{vj}=175^{\circ}\text{C})$	$T_{vj}=25^{\circ}\text{C}$	E_{on}		5.30	mJ	
		$T_{vj}=125^{\circ}\text{C}$			7.50		
		$T_{vj}=175^{\circ}\text{C}$			8.50		
Turn-off energy loss per pulse 关断损耗	$I_C=75\text{A}, V_{CE}=600\text{V},$ $V_{GE}=\pm 15\text{V}$ $R_{Goff}=5.0\Omega, dv/dt =$ $6300\text{ V}/\mu\text{s} (T_{vj}=175^{\circ}\text{C})$	$T_{vj}=25^{\circ}\text{C}$	E_{off}		5.00	mJ	
		$T_{vj}=125^{\circ}\text{C}$			7.20		
		$T_{vj}=175^{\circ}\text{C}$			8.30		

SC Data 短路耐量	$V_{CE} = 800V$, $V_{GE} = \pm 15V$	$t_p \leq 8\mu s$, $T_{vj} = 125^\circ C$	I_{sc}		340		A
		$t_p \leq 7\mu s$, $T_{vj} = 175^\circ C$			320		
Thermal Resistance, Junction to Case 结-壳热阻	Per IGBT/单个 IGBT		R_{thJC}		0.290		K/W
Temperature under switching conditions ²⁾ 工作温度			$T_{vj\ op}$	-40		175	$^\circ C$

Diode, Inverter / 二极管, 逆变部分 Maximum Rated Values / 最大标称参数

Repetitive peak reverse voltage 可重复反向峰值电压	$T_{vj} = 25^\circ C$	V_{RRM}	1200	V
Continuous DC Forward Current 可连续正向直流电流		$I_{F\ nom}$	75	A
Repetitive Peak Forward Current 可重复正向峰值电流	$I_{FRM} = 2 \times I_{F\ nom}$	I_{FRM}	150	A

Characteristic Values / 性能参数

			min.	typ.	max.		
Forward Voltage ¹⁾ 正向通态压降	$I_F = 75A$, $V_{GE} = 0V$ $I_F = 75A$, $V_{GE} = 0V$ $I_F = 75A$, $V_{GE} = 0V$	$T_{vj} = 25^\circ C$ $T_{vj} = 125^\circ C$ $T_{vj} = 175^\circ C$	V_F	1.86 2.03 2.04	2.60		V
Peak Reverse Recovery Current 反向恢复峰值电流	$I_F = 75A$, $V_R = 600V$ $-di_F/dt = 950A/\mu s$ ($T_{vj} = 175^\circ C$), $V_{GE} = -8V$	$T_{vj} = 25^\circ C$ $T_{vj} = 125^\circ C$ $T_{vj} = 175^\circ C$	I_{RM}	60 65 75			A
Recovery Charge 反向恢复电荷	$I_F = 75A$, $V_R = 600V$ $-di_F/dt = 950A/\mu s$ ($T_{vj} = 175^\circ C$), $V_{GE} = -8V$	$T_{vj} = 25^\circ C$ $T_{vj} = 125^\circ C$ $T_{vj} = 175^\circ C$	Q_R	3.40 6.50 8.20			μC
Reverse Recovery Energy 反向恢复损耗	$I_F = 75A$, $V_R = 600V$ $-di_F/dt = 950A/\mu s$ ($T_{vj} = 175^\circ C$), $V_{GE} = -8V$	$T_{vj} = 25^\circ C$ $T_{vj} = 125^\circ C$ $T_{vj} = 175^\circ C$	E_{rec}	1.25 2.85 3.75			mJ
Thermal Resistance, Junction to Case 结-壳热阻	Per Diode / 单个 Diode		R_{thJC}	0.445			K/W
Temperature under switching conditions ²⁾ 工作温度			$T_{vj\ op}$	-40		175	$^\circ C$

Diode, Rectifier / 二极管，整流部分
Maximum Rated Values / 最大标称参数

Repetitive peak reverse voltage 可重复反向峰值电压	$T_{vj}=25^{\circ}\text{C}$	V_{RRM}	1800	V
Maximum RMS Forward Current Per Chip 单芯片最大正向电流有效值		I_{FRMSM}	75	A
Surge Forward Current 正向浪涌电流	$t_p=10\text{ms}, \sin 180^{\circ}, T_{vj}=25^{\circ}\text{C}$	I_{FSM}	840	A
I^2t Value I^2t 值	$t_p=10\text{ms}, \sin 180^{\circ}, T_{vj}=25^{\circ}\text{C}$	I^2t	3528	A^2s

Characteristic Values / 性能参数

			min.	typ.	max.	
Forward Voltage 正向通态压降	$I_F=75\text{A}, T_{vj}=25^{\circ}\text{C}$ $I_F=75\text{A}, T_{vj}=150^{\circ}\text{C}$	V_F		1.18 1.13		V
Reverse Current 反向漏电流	$V_{RRM}=1800\text{V}, T_{vj}=25^{\circ}\text{C}$	I_{RM}			200	μA
Thermal Resistance, Junction to Case 结-壳热阻		R_{thJC}		0.311		K/W
Temperature under switching conditions ²⁾ 工作温度		$T_{vj\text{op}}$	-40		175	$^{\circ}\text{C}$

IGBT, Brake-Choppe / IGBT，制动-斩波器
Maximum Rated Values / 最大标称参数

Collector-emitter Voltage 集电极-发射极电压	$T_{vj}=25^{\circ}\text{C}$	V_{CES}	1200	V
Continuous DC collector current 集电极连续直流电流		$I_{C\text{nom}}$	75	A
	$T_C=100^{\circ}\text{C}, T_{vj\text{max}}=175^{\circ}\text{C}$	I_C	95	A
Repetitive Peak collector current 集电极可重复峰值电流	$I_{CRM}=2 \times I_{C\text{nom}}$	I_{CRM}	150	A
Gate-emitter peak voltage 门极-发射极峰值电压		V_{GES}	± 20	V

Characteristic Values / 性能参数

			min.	typ.	max.	
Collector-emitter saturation Voltage ¹⁾ 集电极-发射极饱和压降	$I_C=75\text{A}, V_{GE}=15\text{V}, T_{vj}=25^{\circ}\text{C}$ $I_C=75\text{A}, V_{GE}=15\text{V}, T_{vj}=125^{\circ}\text{C}$ $I_C=75\text{A}, V_{GE}=15\text{V}, T_{vj}=175^{\circ}\text{C}$	V_{CESat}		1.45 1.65 1.72	1.80	V
Gate Threshold Voltage 门极阈值电压	$V_{CE}=V_{GE}, I_C=1.5\text{mA}, T_{vj}=25^{\circ}\text{C}$	V_{GEth}	5.5	6.0	7.0	V
Gate Charge 门极电荷	$V_{GE}=-8\text{V}/15\text{V}, V_{CE}=600\text{V}, T_{vj}=25^{\circ}\text{C}$	Q_G		0.67		μC
Internal Gate Resistor 内置门极电阻	$T_{vj}=25^{\circ}\text{C}$	R_{Gint}		1.65		Ω

Input Capacitance 输入电容	$V_{CE} = 25V, V_{GE} = 0V$ $f = 100KHz$	C_{ies}	16.5	nF
Reverse Transfer Capacitance 反向传输电容		C_{res}	0.05	nF
Collector-emitter Cutoff Current 集电极-发射极关断漏电流	$V_{CE}=1200V, V_{GE}=0V,$ $T_{vj}=25^{\circ}C$	I_{CES}	200	μA
Gate-emitter Leakage Current 门极-发射极漏电流	$V_{CE}=0V, V_{GE}=20V,$ $T_{vj}=25^{\circ}C$	I_{GES}	200	nA
Turn-on Delay Time, Inductive Load 开通延迟时间, 感性负载	$I_C=75A, V_{CE}=600V$ $V_{GE}=\pm 15V$ $R_{Gon}=6.0\Omega$	$T_{vj}=25^{\circ}C$ $T_{vj}=125^{\circ}C$ $T_{vj}=175^{\circ}C$	t_{don}	90 95 95 ns
Rise Time, Inductive Load 上升时间, 感性负载	$I_C=75A, V_{CE}=600V$ $V_{GE}=\pm 15V$ $R_{Gon}=6.0\Omega$	$T_{vj}=25^{\circ}C$ $T_{vj}=125^{\circ}C$ $T_{vj}=175^{\circ}C$	t_r	110 125 130 ns
Turn-off Delay Time, Inductive Load 关断延迟时间, 感性负载	$I_C=75A, V_{CE}=600V$ $V_{GE}=\pm 15V$ $R_{Goff}=5.0\Omega$	$T_{vj}=25^{\circ}C$ $T_{vj}=125^{\circ}C$ $T_{vj}=175^{\circ}C$	t_{doff}	235 380 300 ns
Fall Time, Inductive Load 下降时间, 感性负载	$I_C=75A, V_{CE}=600V$ $V_{GE}=\pm 15V$ $R_{Goff}=5.0\Omega$	$T_{vj}=25^{\circ}C$ $T_{vj}=125^{\circ}C$ $T_{vj}=175^{\circ}C$	t_f	115 185 240 ns
Turn-on energy loss per pulse 开通损耗	$I_C=75A, V_{CE}=600V,$ $V_{GE}=\pm 15V$ $R_{Gon}=6.0\Omega, di/dt =$ $450 A/\mu s (T_{vj}=175^{\circ}C)$	$T_{vj}=25^{\circ}C$ $T_{vj}=125^{\circ}C$ $T_{vj}=175^{\circ}C$	E_{on}	11.1 15.3 18.2 mJ
Turn-off energy loss per pulse 关断损耗	$I_C=75A, V_{CE}=600V,$ $V_{GE}=\pm 15V$ $R_{Goff}=5.0\Omega, dv/dt =$ $7000 V/\mu s (T_{vj}=175^{\circ}C)$	$T_{vj}=25^{\circ}C$ $T_{vj}=125^{\circ}C$ $T_{vj}=175^{\circ}C$	E_{off}	5.10 7.40 8.30 mJ
SC Data 短路耐量	$V_{CE}=800V,$ $V_{GE}=\pm 15V$	$t_p \leq 8\mu s, T_{vj}=150^{\circ}C$ $t_p \leq 6\mu s, T_{vj}=175^{\circ}C$	I_{sc}	340 320 A
Thermal Resistance, Junction to Case 结-壳热阻	Per IGBT/单个IGBT		R_{thJC}	0.290 K/W
Temperature under switching conditions ²⁾ 工作温度			$T_{vj op}$	-40 175 $^{\circ}C$

Diode, Brake-Chopper / 二极管, 制动-斩波器

Maximum Rated Values / 最大标称参数

Repetitive peak reverse voltage 可重复反向峰值电压	$T_{vj}=25^{\circ}C$	V_{RRM}	1200	V
Continuous DC Forward Current 可连续正向直流电流		$I_{F nom}$	60	A
Repetitive Peak Forward Current 可重复正向峰值电流	$I_{FRM}=2 \times I_{F nom}$	I_{FRM}	120	A

Characteristic Values / 性能参数

			min.	typ.	max.		
Forward Voltage ¹⁾ 正向通态压降	$I_F=60A, V_{GE}=0V$ $I_F=60A, V_{GE}=0V$ $I_F=60A, V_{GE}=0V$	$T_{vj}=25^{\circ}C$ $T_{vj}=125^{\circ}C$ $T_{vj}=175^{\circ}C$	V_F		1.70 1.86 1.84	2.40	V
Peak Reverse Recovery Current 反向恢复峰值电流	$I_F=60A, V_R=600V$ $-di_F/dt=240A/us(T_{vj}=175^{\circ}C)$ $V_{GE}=-15V$	$T_{vj}=25^{\circ}C$ $T_{vj}=125^{\circ}C$ $T_{vj}=175^{\circ}C$	I_{RM}		24 28 32		A
Recovery Charge 反向恢复电荷	$I_F=60A, V_R=600V$ $-di_F/dt=240A/us(T_{vj}=175^{\circ}C)$ $V_{GE}=-15V$	$T_{vj}=25^{\circ}C$ $T_{vj}=125^{\circ}C$ $T_{vj}=175^{\circ}C$	Q_R		3.00 5.80 7.80		μC
Reverse Recovery Energy 反向恢复损耗	$I_F=60A, V_R=600V$ $-di_F/dt=240A/us(T_{vj}=175^{\circ}C)$ $V_{GE}=-15V$	$T_{vj}=25^{\circ}C$ $T_{vj}=125^{\circ}C$ $T_{vj}=175^{\circ}C$	E_{rec}		0.78 1.80 2.60		mJ
Thermal Resistance, Junction to Case 结-壳热阻	Per Diode / 单个 Diode		R_{thJC}		0.487		K/W
Temperature under switching conditions ²⁾ 工作温度			$T_{vj op}$	-40		175	$^{\circ}C$

NTC-Thermistor/ NTC-热敏电阻
Characteristic Values / 性能参数

			min.	typ.	max.	
Rated Resistance 标称电阻	$T_{NTC}=25^{\circ}C$	R_{25}		5		K Ω
Deviation of R100 R100 偏移值	$T_{NTC}=100^{\circ}C, R_{100}=465\Omega$	$\Delta R/R$	-7.3		7.3	%
Power Dissipation 功率耗散	$T_{NTC}=25^{\circ}C$	P_{25}			10	mW
B-Value B 值	$R_2=R_{25} \exp[B_{25/50}(1/T_2-1/(298.15K))]$	$B_{25/50}$		3380		K
	$R_2=R_{25} \exp[B_{25/80}(1/T_2-1/(298.15K))]$	$B_{25/80}$		3470		
	$R_2=R_{25} \exp[B_{25/100}(1/T_2-1/(298.15K))]$	$B_{25/100}$		3520		

Module / 模块

Isolation Test Voltage 绝缘测试电压	RMS, f=50Hz, t=1min	V_{ISOL}		3.0		KV
Material of Module Baseplate 模块底板材料				Cu		
Internal Isolation 内部绝缘	基本绝缘 (class 1, IEC 61140) Basic insulation (class1, IEC 61140)			Al_2O_3		
Creepage Distance 爬电距离	端子-散热片 terminal to heatsink 端子-端子 terminal to terminal			10.0		mm
Clearance 电气间隙	端子-散热片 terminal to heatsink 端子-端子 terminal to terminal			7.5		mm
Comparative Tracking Index 相对漏电起痕指数		CTI		>200		

			min.	typ.	max.	
Stray Inductance Module 模块杂散电感		L_{sCE}		30		nH
Module lead resistance 模块引脚电阻	$T_C = 25^\circ\text{C}$, 每个开关 per switch	$R_{AA'+CC}$		2.9		m Ω
Module lead resistance 模块引脚电阻	$T_C = 25^\circ\text{C}$, 每个开关 per switch	$R_{CC'+EE}$		3.9		m Ω
Storage Temperature 贮存温度		T_{stg}	-40		125	$^\circ\text{C}$
Modul Mounting torque 模块安装扭距	M5	M	4.0		6.0	Nm
Weight 重量		G		310		g

注：1) Terminal impedance is not included.

不包含端子阻抗。

2) $T_{vj\ op} > 150^\circ\text{C}$ is only allowed for operation at overload conditions

$T_{vj\ op} > 150^\circ\text{C}$ 仅允许在过载条件下运行。

输出特性 IGBT, 逆变器(典型值)

Output characteristic IGBT Inverter (typical)

$I_C = f(V_{CE})$,

$V_{GE} = 15V$

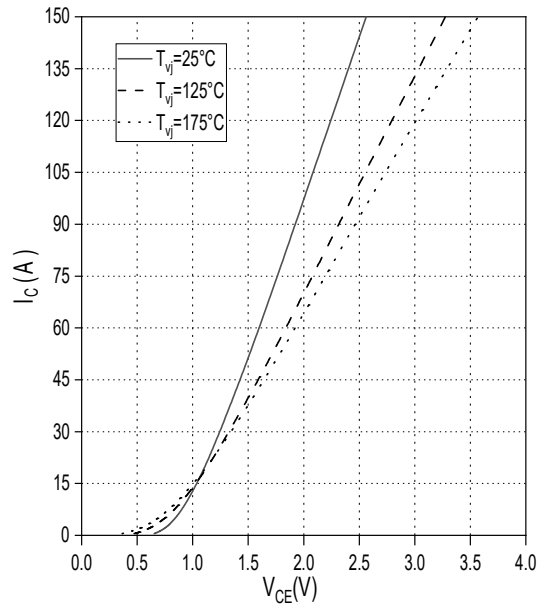

输出特性 IGBT, 逆变器(典型值)

Output characteristic IGBT Inverter (typical)

$I_C = f(V_{CE})$,

$T_{vj} = 175^\circ C$

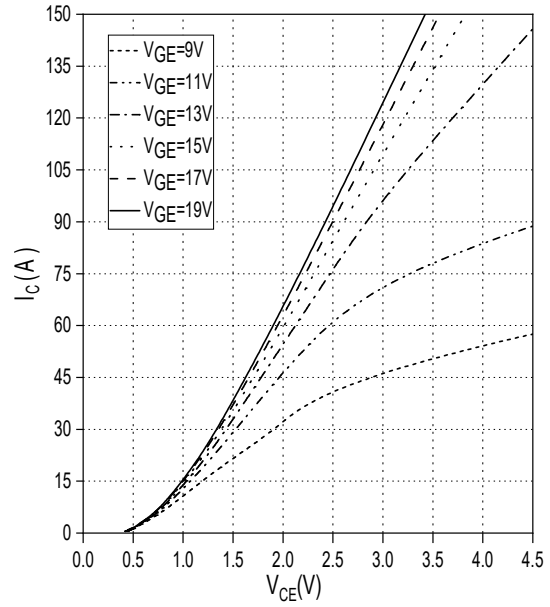

传输特性 IGBT, 逆变器 (典型值)

Transfer characteristic IGBT, Inverter (typical)

$I_C = f(V_{GE})$,

$V_{CE} = 20V$

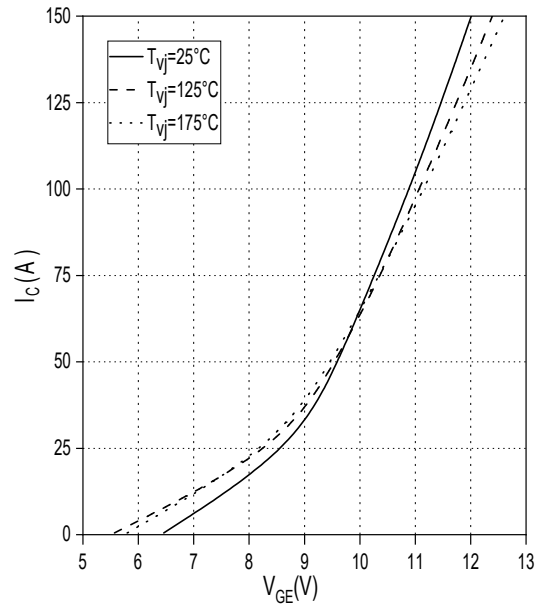

开关损耗 IGBT, 逆变器 (典型值)

switching losses IGBT, Inverter (typical)

$E_{on} = f(I_C), E_{off} = f(I_C), V_{GE} = \pm 15V$,

$R_{Gon} = 6.0\Omega, R_{Goff} = 5.0\Omega, V_{CE} = 600V$

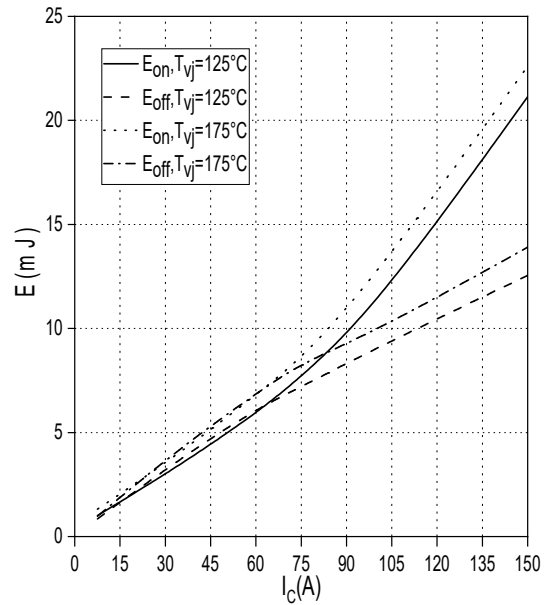

开关损耗 IGBT, 逆变器 (典型值)
Switching losses IGBT, Inverter (typical)
 $V_{GE} = \pm 15V, I_C = 75A, V_{CE} = 600V$

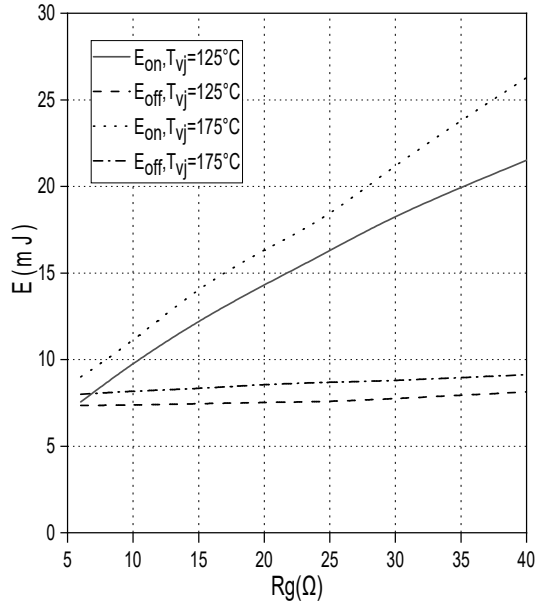

瞬态热阻抗 IGBT, 逆变器
transient thermal impedance IGBT, Inverter
 $Z_{thJC} = f(t)$

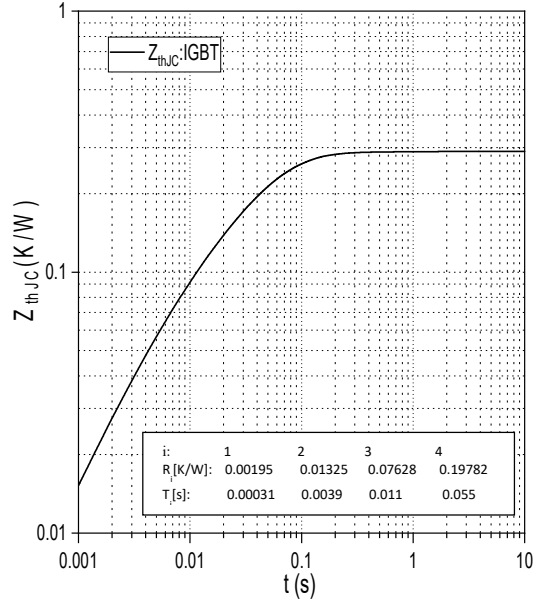

反偏安全工作区 IGBT, 逆变器 (RBSOA)
Reverse bias safe operating area IGBT, Inverter (RBSOA) $I_C = f(V_{CE})$
 $V_{GE} = \pm 15V, R_{Goff} = 5.0\Omega, T_{vj} = 175^\circ C$

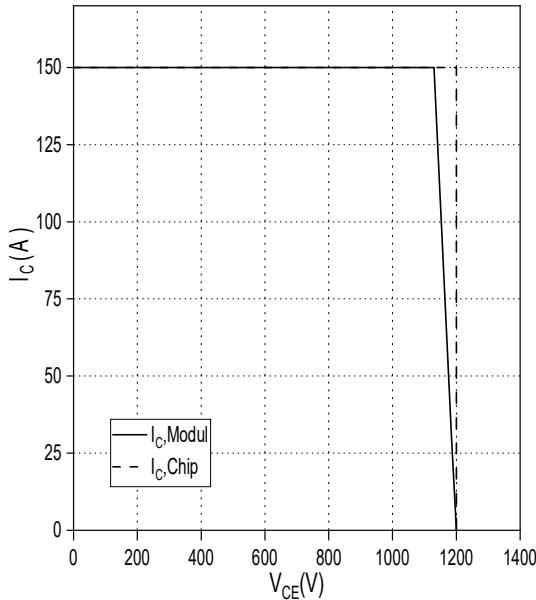

正向偏压特性二极管, 逆变器 (典型值)
forward characteristic of Diode, Inverter (typical)
 $I_F = f(V_F)$

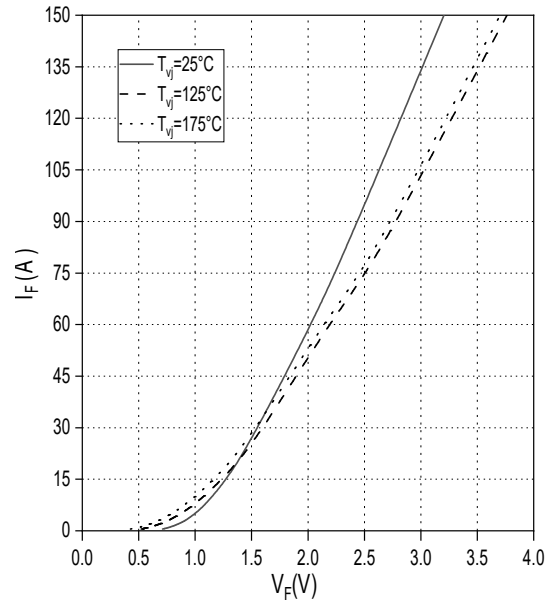

栅极电荷特性, IGBT, 逆变器 (典型)

Gate charge characteristic, IGBT, Inverter (typical)

$V_{GE} = f(Q_G)$

$I_C = 75\text{ A}, T_{vj} = 25\text{ }^\circ\text{C}$

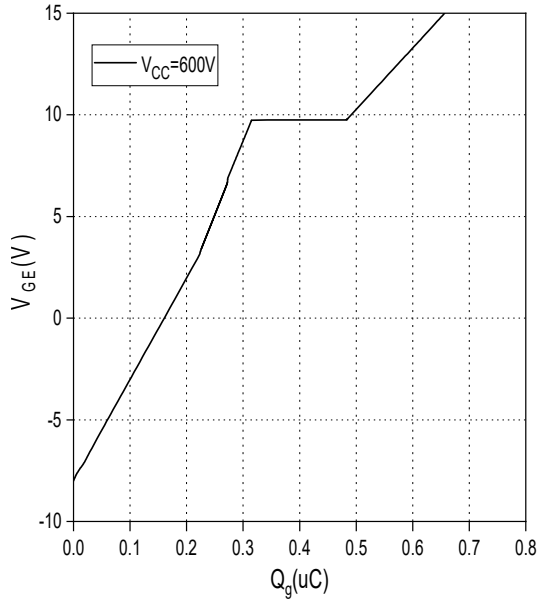

电容特性, IGBT, 逆变器 (典型)

Capacity characteristic, IGBT, Inverter (typical)

$C = f(V_{CE})$

$f = 100\text{ kHz}, V_{GE} = 0\text{ V}, T_{vj} = 25\text{ }^\circ\text{C}$

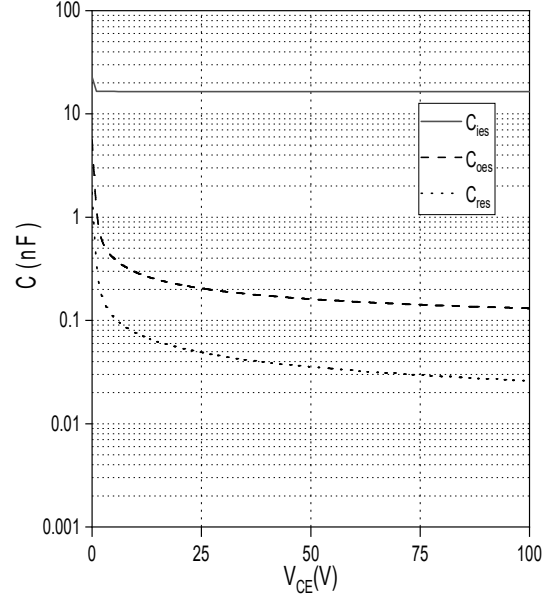

开关损耗 二极管, 逆变器 (典型值)

Switching losses Diode, Inverter (typical)

$E_{rec} = f(I_F)$

$R_{Gon} = 6.0\Omega, V_{CE} = 600\text{ V}$

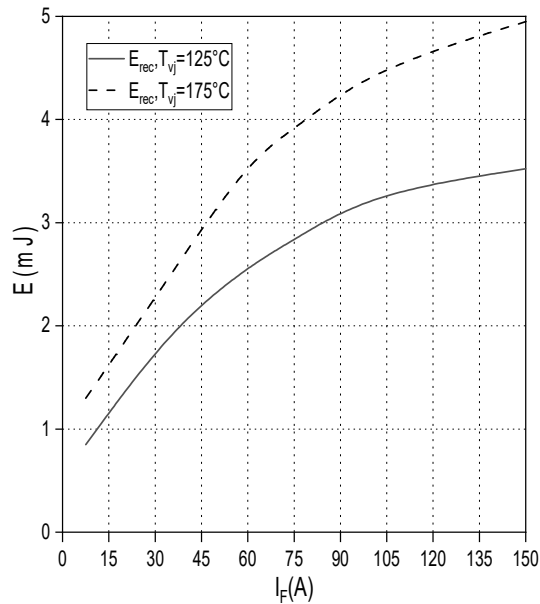

开关损耗 二极管, 逆变器 (典型值)

switching losses Diode, Inverter (typical)

$E_{rec} = f(R_G)$

$I_F = 75\text{ A}, V_{CE} = 600\text{ V}$

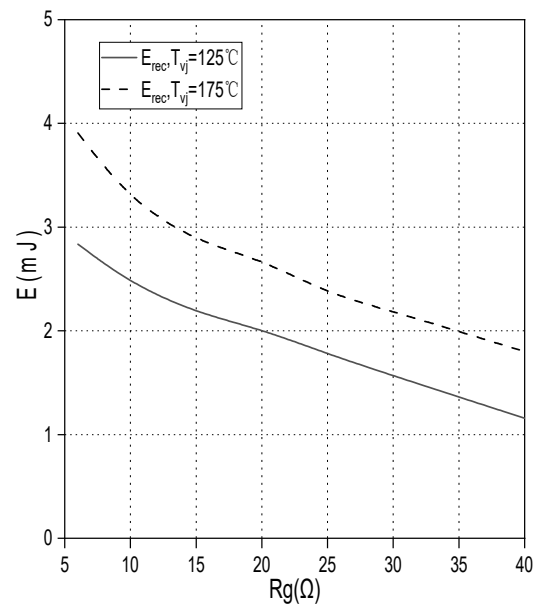

瞬态热阻抗二极管, 逆变器

transient thermal impedance Diode, Inverter

$Z_{thJC} = f(t)$

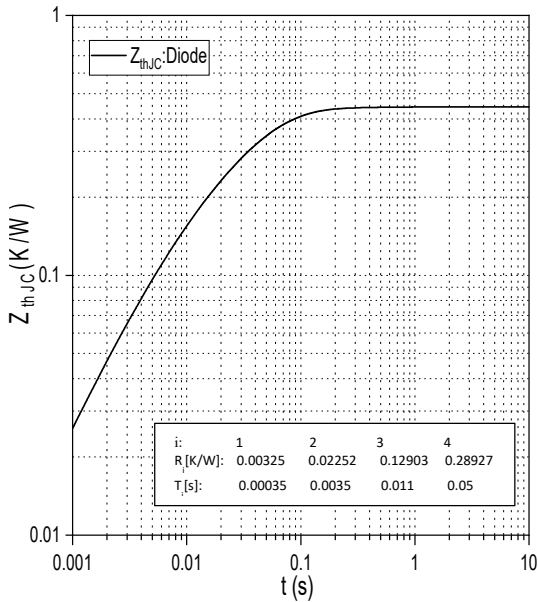

正向偏压特性 二极管, 整流器 (典型值)

forward characteristic of Diode Rectifier (typical)

$I_F = f(V_F)$

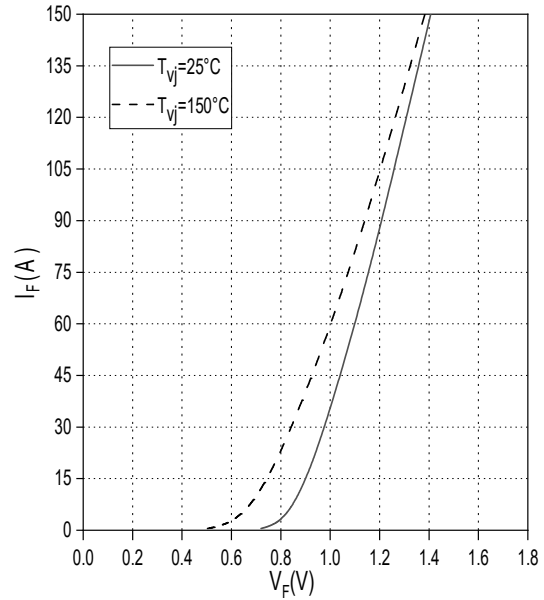

输出特性 IGBT, 制动-斩波器 (典型值)

Output characteristic IGBT, Brake-Chopper (typical)

$I_C = f(V_{CE})$

$V_{GE} = 15V$

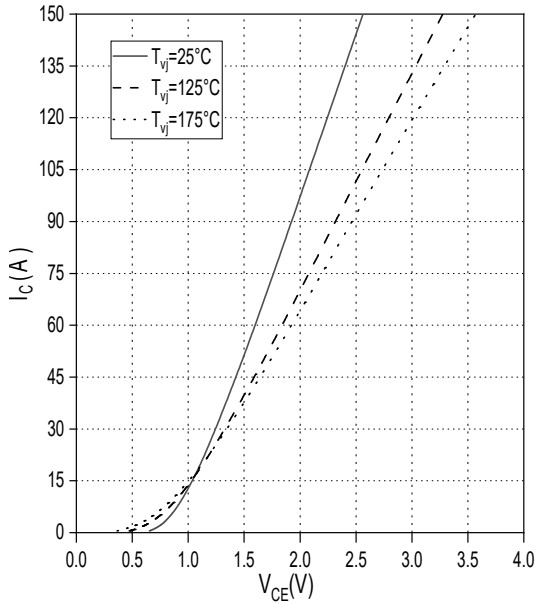

正向偏压特性 二极管, 制动-斩波器 (典型值)

forward characteristic of Diode, Brake-Chopper (typical)

$I_F = f(V_F)$

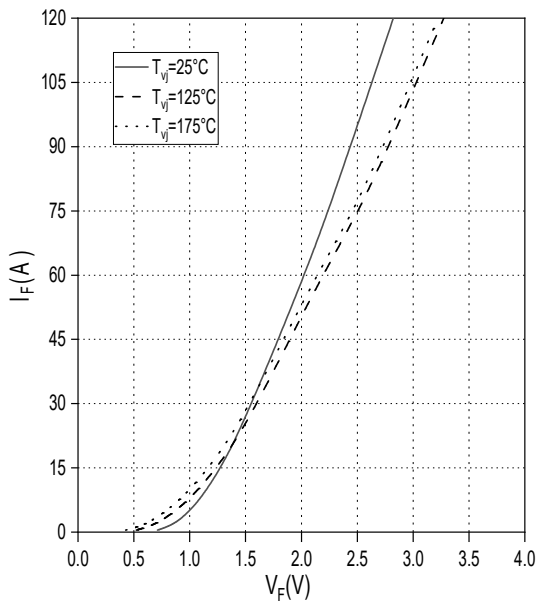

负温度系数热敏电阻 温度特性 (典型值)

NTC-Thermistor-temperature characteristic (typical)

$R = f(T)$

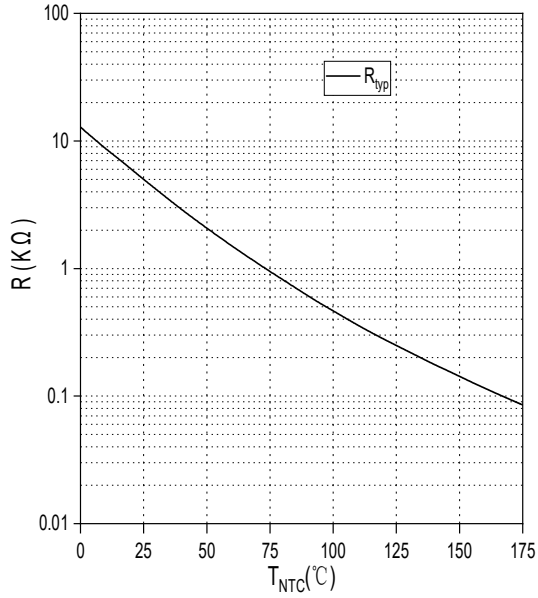

瞬态热阻抗二极管, 整流

transient thermal impedance Diode, Rectifier

$Z_{thJC} = f(t)$

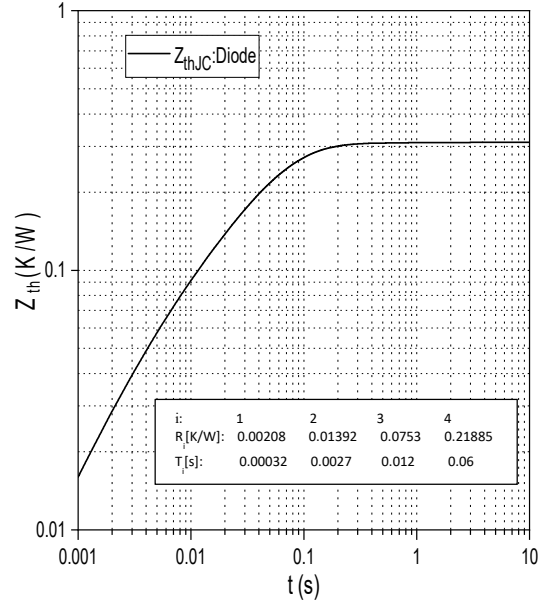

Internal Circuit:

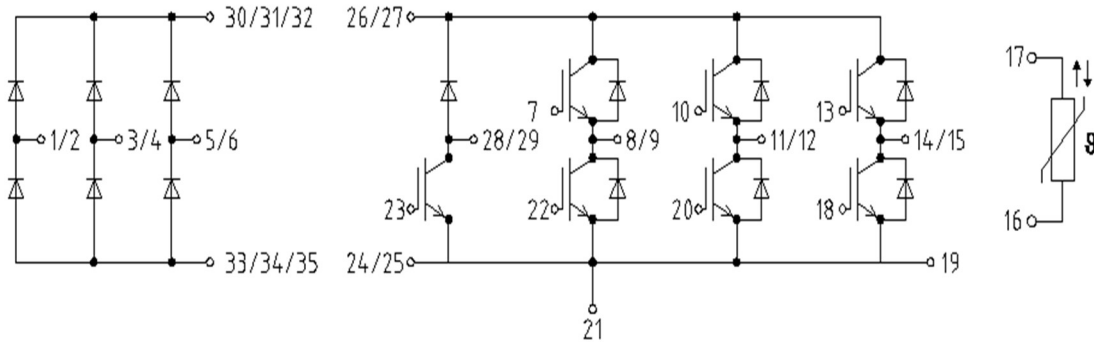

Package Dimension
Dimensions in Millimeters

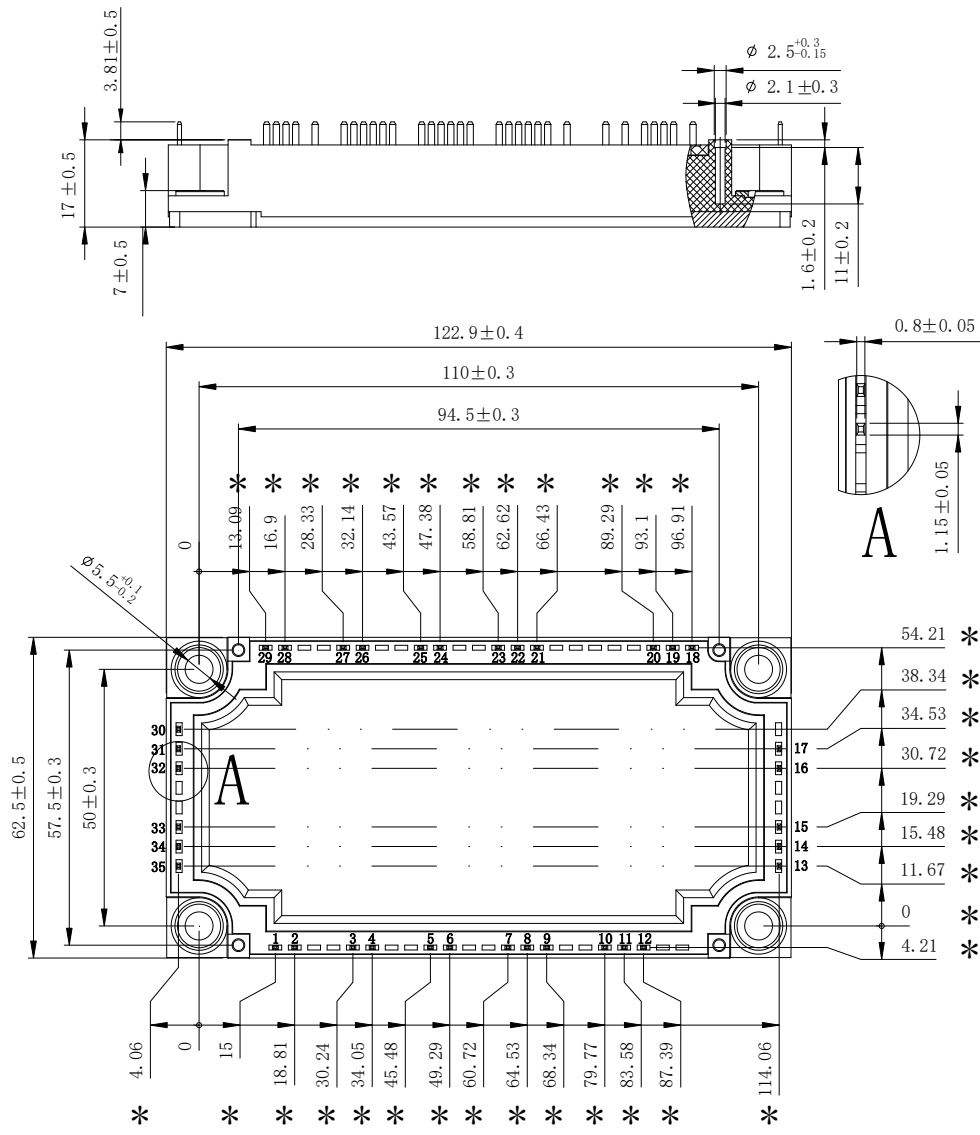

*=all dimensions with tolerance of ± 0.5