

A4 package: 750V 600A IGBT module

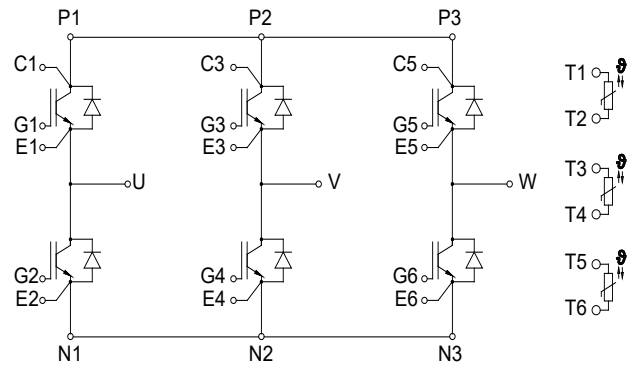
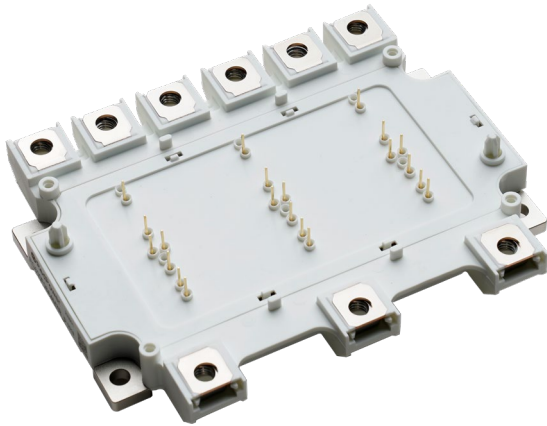

等效电路图

Equivalent Circuit Schematic

Features:

- 750V 600A, $V_{CE(sat)} = 1.35V@25^{\circ}C$
- High RBSOA capability
- Micro pattern trench/FS technology
- Low switching losses
- High SC capability
- Direct Cooled Base Plate with PinFin

产品特性:

- 750V 600A, $V_{CE(sat)} = 1.35V@25^{\circ}C$
- 高 RBSOA 能力
- 微沟槽/场终止技术
- 低开关损耗
- 高短路能力
- 直接冷却 PinFin 基板

Typical Applications:

- Automotive Applications
- Motor Drives
- Inverters

典型应用:

- 汽车应用
- 电机驱动
- 逆变器

IGBT, Inverter / IGBT, 逆变部分
Maximum Rated Values / 最大标称参数

Collector-emitter voltage 集电极-发射极电压	$T_{vj}=25^{\circ}\text{C}$	V_{CES}	750	V
Continuous DC collector current 集电极连续直流电流		$I_{C\text{ nom}}$	600	A
	$T_C=65^{\circ}\text{C}, T_{vj\text{ max}}=175^{\circ}\text{C}$	I_C	695 ¹⁾	A
Repetitive peak collector current 集电极可重复峰值电流	$t_p=1\text{ms}$	I_{CRM}	1200	A
Total power dissipation 功率损耗	$T_C=75^{\circ}\text{C}, T_{vj\text{ max}}=175^{\circ}\text{C}$	P_{tot}	934 ¹⁾	W
Gate-emitter peak voltage 门极-发射极峰值电压		V_{GES}	± 20	V

Characteristic Values / 性能参数

				min.	typ.	max.	
Collector-emitter saturation voltage 集电极-发射极饱和压降	$I_C=600\text{A}, V_{GE}=15\text{V}$	$T_{vj}=25^{\circ}\text{C}$ $T_{vj}=150^{\circ}\text{C}$ $T_{vj}=175^{\circ}\text{C}$	V_{CESat}		1.35 1.50 1.54		V
Gate threshold voltage 门极阈值电压	$V_{CE}=V_{GE}, I_C=8\text{mA}$	$T_{vj}=25^{\circ}\text{C}$	V_{GEth}	5.00	6.00	7.00	V
Internal gate resistor 内置门极电阻		$T_{vj}=25^{\circ}\text{C}$	R_{Gint}		0.65		Ω
Input capacitance 输入电容	$V_{CE}=25\text{V}, V_{GE}=0\text{V}, f=100\text{kHz}$	$T_{vj}=25^{\circ}\text{C}$	C_{ies}		70.6		nF
Reverse transfer capacitance 反向传输电容	$V_{CE}=25\text{V}, V_{GE}=0\text{V}, f=100\text{kHz}$	$T_{vj}=25^{\circ}\text{C}$	C_{res}		0.26		nF
Gate charge 门极电荷	$V_{GE}=-8\text{V}\sim+15\text{V}, V_{CE}=400\text{V}$		Q_G		2.92		μC
Collector-emitter cut-off current 集电极-发射极关断漏电流	$V_{CE}=750\text{V}, V_{GE}=0\text{V}$	$T_{vj}=25^{\circ}\text{C}$	I_{CES}			1.0	mA
Gate-emitter leakage current 门极-发射极漏电流	$V_{CE}=0\text{V}, V_{GE}=20\text{V}$	$T_{vj}=25^{\circ}\text{C}$	I_{GES}			500	nA
Turn-on delay time, inductive load 开通延迟时间, 感性负载	$I_C=600\text{A}, V_{CE}=400\text{V}$ $V_{GE}=-8\text{V}/15\text{V}, R_{Gon}=2.0\Omega$	$T_{vj}=25^{\circ}\text{C}$ $T_{vj}=150^{\circ}\text{C}$ $T_{vj}=175^{\circ}\text{C}$	t_{don}		157 187 190		ns
Rise time, inductive load 上升时间, 感性负载	$I_C=600\text{A}, V_{CE}=400\text{V}$ $V_{GE}=-8\text{V}/15\text{V}, R_{Gon}=2.0\Omega$	$T_{vj}=25^{\circ}\text{C}$ $T_{vj}=150^{\circ}\text{C}$ $T_{vj}=175^{\circ}\text{C}$	t_r		79 100 105		ns
Turn-off delay time, inductive load 关断延迟时间, 感性负载	$I_C=600\text{A}, V_{CE}=400\text{V}$ $V_{GE}=-8\text{V}/15\text{V}, R_{Goff}=12\Omega$	$T_{vj}=25^{\circ}\text{C}$ $T_{vj}=150^{\circ}\text{C}$ $T_{vj}=175^{\circ}\text{C}$	t_{doff}		969 1053 1067		ns
Fall time, inductive load 下降时间, 感性负载	$I_C=600\text{A}, V_{CE}=400\text{V}$ $V_{GE}=-8\text{V}/15\text{V}, R_{Goff}=12\Omega$	$T_{vj}=25^{\circ}\text{C}$ $T_{vj}=150^{\circ}\text{C}$ $T_{vj}=175^{\circ}\text{C}$	t_f		89 90 90		ns
Turn-on energy loss per pulse 开通损耗	$I_C=600\text{A}, V_{CE}=400\text{V}$ $V_{GE}=-8\text{V}/15\text{V}, R_{Gon}=2.0\Omega,$ $di/dt(T_{vj}=25^{\circ}\text{C})=5929\text{A/us}$ $di/dt(T_{vj}=175^{\circ}\text{C})=4468\text{A/us}$	$T_{vj}=25^{\circ}\text{C}$ $T_{vj}=150^{\circ}\text{C}$ $T_{vj}=175^{\circ}\text{C}$	E_{on}		23.5 30.4 33.0		mJ
Turn-off energy loss per pulse 关断损耗	$I_C=600\text{A}, V_{CE}=400\text{V}$ $V_{GE}=-8\text{V}/15\text{V}, R_{Goff}=12\Omega$ $dv/dt(T_{vj}=25^{\circ}\text{C})=6349\text{A/us}$ $dv/dt(T_{vj}=175^{\circ}\text{C})=3968\text{A/us}$	$T_{vj}=25^{\circ}\text{C}$ $T_{vj}=150^{\circ}\text{C}$ $T_{vj}=175^{\circ}\text{C}$	E_{off}		42.0 44.8 45.9		mJ

SC data 短路耐量	$V_{CC}=400V, V_{GE}=-8V/15V$ $V_{CEmax}=V_{CES}-L_{SCE} \cdot di/dt$	$t_p \leq 6\mu s$ $t_p \leq 6\mu s$	$T_{vj}=25^\circ C$ $T_{vj}=175^\circ C$	I_{sc}		2900 2300		A
Thermal resistance, junction to cooling fluid 结-冷却液热阻	Per IGBT/单个 IGBT Cooling fluid = 50%water/50% ethylene glycol; $\Delta V/\Delta T=10.0dm^3/min$ $T_F=65^\circ C$			R_{thJF}		0.107		K/W
Temperature under switching conditions 工作温度	t_{op} continuous for 10s within a period of 30s, occurrence maximum 3000 times over lifetime			$T_{vj op}$	-40 150		150 175	$^\circ C$

Diode, Inverter / 二极管, 逆变部分

Maximum Rated Values / 最大标称参数

Repetitive peak reverse voltage 可重复反向峰值电压	$T_{vj}=25^\circ C$	V_{RRM}	750	V
Continuous DC forward current 可连续正向直流电流		I_{Fnom}	600	A
Repetitive peak forward current 可重复正向峰值电流	$I_{FRM}=2 \times I_F$	I_{FRM}	1200 ¹⁾	A

Characteristic Values / 性能参数

		min. typ. max.				
Forward voltage ¹⁾ 正向通态压降	$I_F=600A, V_{GE}=0V$	$T_{vj}=25^\circ C$ $T_{vj}=150^\circ C$ $T_{vj}=175^\circ C$	V_F	1.45 1.40 1.35	V	
Reverse recovery time 反向恢复时间	$I_F=600A, V_R=400V$ $di_F/dt=7143A/us(T_{vj}=150^\circ C)V_{GE}=-8V$	$T_{vj}=25^\circ C$ $T_{vj}=150^\circ C$ $T_{vj}=175^\circ C$	t_{rr}	137 171 182	ns	
Peak reverse recovery current 反向恢复峰值电流	$I_F=600A, V_R=400V$ $di_F/dt=7143A/us(T_{vj}=150^\circ C)V_{GE}=-8V$	$T_{vj}=25^\circ C$ $T_{vj}=150^\circ C$ $T_{vj}=175^\circ C$	I_{RM}	332 388 396	A	
Recovery charge 反向恢复电荷	$I_F=600A, V_R=400V$ $di_F/dt=7143A/us(T_{vj}=150^\circ C)V_{GE}=-8V$	$T_{vj}=25^\circ C$ $T_{vj}=150^\circ C$ $T_{vj}=175^\circ C$	Q_R	26.4 37.5 41.1	μC	
Reverse recovery energy 反向恢复损耗	$I_F=600A, V_R=400V$ $di_F/dt=7143A/us(T_{vj}=150^\circ C)V_{GE}=-8V$	$T_{vj}=25^\circ C$ $T_{vj}=150^\circ C$ $T_{vj}=175^\circ C$	E_{rec}	4.4 9.9 12.1	mJ	
Thermal resistance, junction to cooling fluid 结-冷却液热阻	Per FRD/单个 FRD Cooling fluid = 50%water/50% ethylene glycol; $\Delta V/\Delta T=10.0dm^3/min$ $T_F=65^\circ C$			R_{thJF}	0.150	K/W
Temperature under switching conditions 工作温度	t_{op} continuous for 10s within a period of 30s, occurrence maximum 3000 times over lifetime			$T_{vj op}$	-40 150	150 175 $^\circ C$

NTC-Thermistor/ NTC-热敏电阻
Characteristic Values / 性能参数

		min.	typ.	max.		
Rated resistance 标称电阻	$T_{NTC}=25^{\circ}C$	R_{25}	-	5	-	K Ω
Deviation of R100 R100 偏移值	$T_{NTC}=100^{\circ}C, R_{100}=493.3\Omega$	$\Delta R/R$	-5	-	5	%
Power dissipation 功率耗散	$T_{NTC}=25^{\circ}C$	P_{25}	-	-	20	mW
B-value B 值	$R_2=R_{25} \exp[B_{25/50}(1/T_2-1/(298.15K))]$	$B_{25/50}$	-	3375	-	K
	$R_2=R_{25} \exp[B_{25/80}(1/T_2-1/(298.15K))]$	$B_{25/80}$	-	3414	-	K
	$R_2=R_{25} \exp[B_{25/100}(1/T_2-1/(298.15K))]$	$B_{25/100}$	-	3436	-	K

Module / 模块

Isolation test voltage 绝缘测试电压	RMS, f=50Hz, t=1min	V_{ISOL}	3		KV
Material of module baseplate 模块底板材料			Cu+Ni		
Internal isolation 内部绝缘			Si_3N_4		
Creepage distance 爬电距离	Terminal to heatsink Terminal to terminal		18.2 8.2		mm
Clearance 电气间隙	Terminal to heatsink Terminal to terminal		18.2 5.9		mm
Comparative tracking index 相对漏电起痕指数		CTI	200 ²⁾		

		min.	typ.	max.		
Stray inductance module 模块杂散电感		L_{sCE}	-	15	-	nH
Module lead resistance, terminals- chip 模块引脚电阻, 端子-芯片	$T_C=25^{\circ}C, \text{ Per Switch}$	R_{CC+EE}	-	1.0	-	m Ω
Storage temperature 贮存温度		T_{stg}	-40	-	125	$^{\circ}C$
Mounting torque for module mounting 模块安装力矩	Screw M5 / M5 螺丝 Baseplate to heatsink	M	4.0	-	6.0	Nm
Terminal connection torque 功率端子连接力矩	Screw M6 / M6 螺丝	M	4.0	-	6.0	Nm
Weight 重量		G	-	715	-	g

- 1) Verified by characterization/design not by test.
非测试值, 设计计算所得。
- 2) CTI is about 200.
CTI 约等于 200。

Circuit Diagram / 曲线图

Output characteristic IGBT, Inverter (typical), Inclusive $R_{CC'+EE'}$

IGBT 输出特性, 逆变 (典型值), 包含 $R_{CC'+EE'}$
 $I_C=f(V_{CE}), V_{GE}=15V$

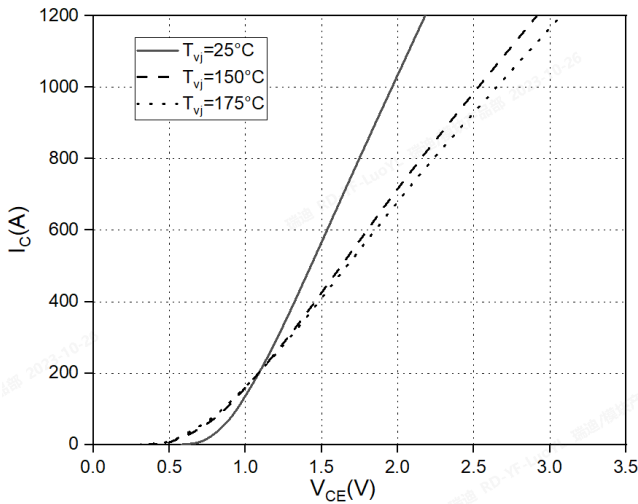

Output characteristic IGBT, Inverter (typical), Inclusive $R_{CC'+EE'}$

IGBT 输出特性, 逆变 ($T_j=150^\circ C$), 包含 $R_{CC'+EE'}$
 $I_C=f(V_{CE}), T_{vj}=175^\circ C$

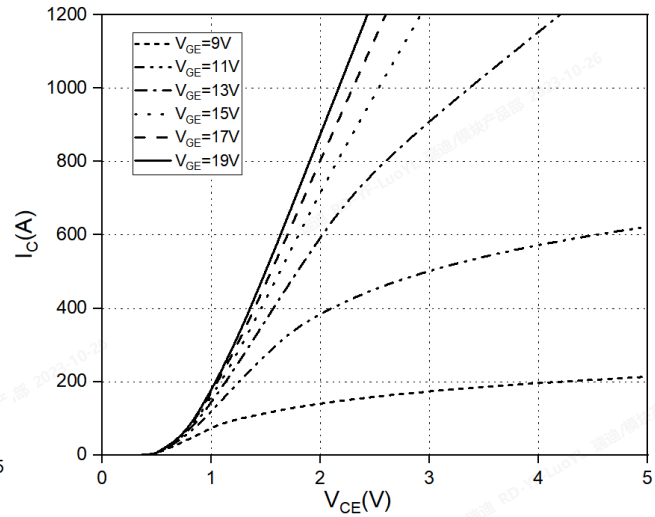

Transfer characteristic IGBT, Inverter (typical), Inclusive $R_{CC'+EE'}$

IGBT 传输特性, 逆变 (典型值), 包含 $R_{CC'+EE'}$
 $I_C=f(V_{GE}), V_{CE}=20V$

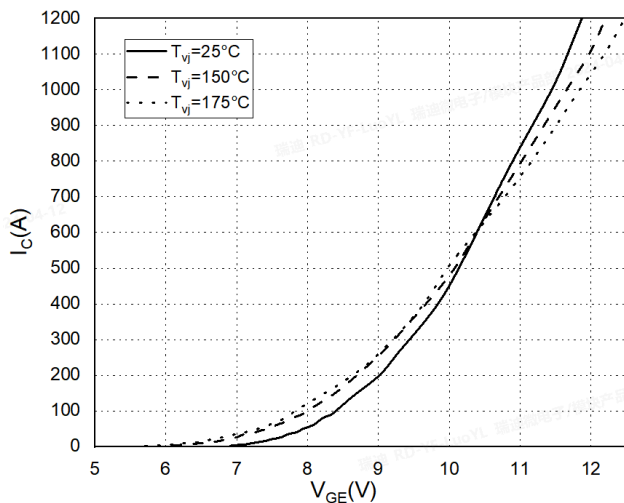

Switching losses IGBT, Inverter (typical), Inclusive $R_{CC'+EE'}$

IGBT 开关损耗, 逆变 (典型值), 包含 $R_{CC'+EE'}$
 $E=f(I_C), V_{GE}=+15V/-8V,$
 $R_{Gon}=2\Omega, R_{Goff}=12\Omega, V_{CE}=400V$

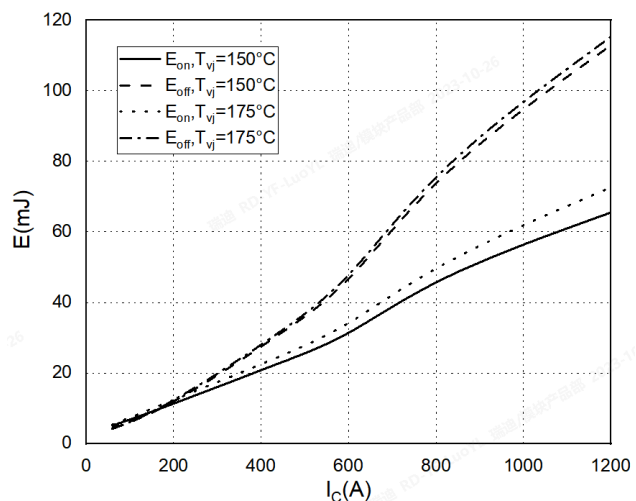

Switching losses IGBT, Inverter (typical), Inclusive $R_{CC'+EE'}$

IGBT 开关损耗, 逆变 (典型值), 包含 $R_{CC'+EE'}$
 $E_{on}=f(R_G)$, $E_{off}=f(R_G)$,
 $V_{GE}=+15V/-8V$, $I_C=600A$, $V_{CE}=400V$

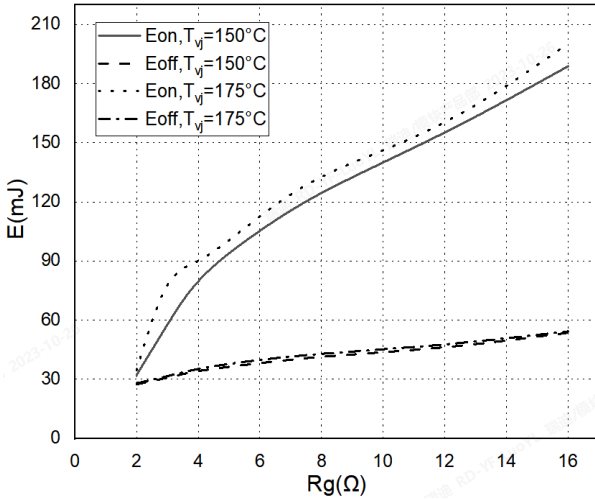

Transient thermal impedance IGBT, Inverter

IGBT 瞬态热阻, 逆变
 $Z_{thJC}=f(t)$
 Cooling fluid = 50% water/50% ethylene glycol;
 $\Delta V/\Delta T=10.0 dm^3/min$; $T_F=65^\circ C$

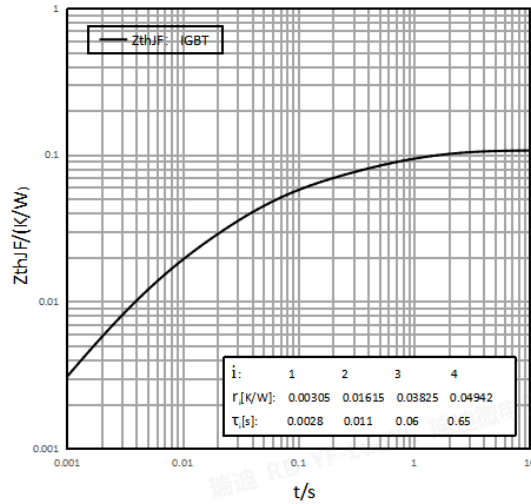

Reverse bias safe operating area IGBT, Inverter (RBSOA)

IGBT 反向安全工作区, 逆变 (RBSOA)
 $I_C=f(V_{CE})$, $V_{GE}=+15V/-8V$, $R_{Goff}=12\Omega$, $T_{vj}=175^\circ C$

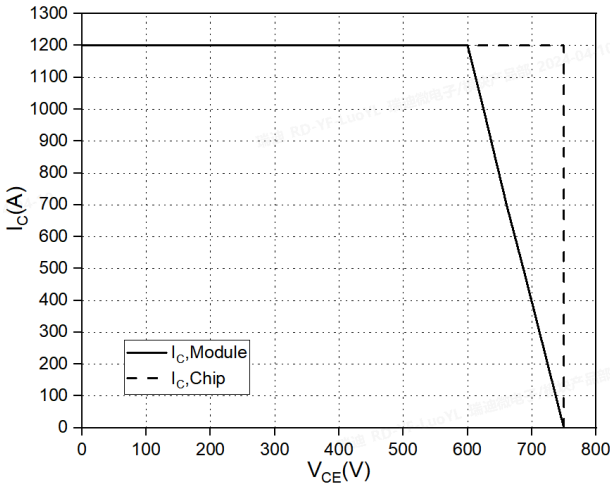

Forward characteristic FRD, Inverter (typical), Inclusive $R_{CC'+EE'}$

FRD 正向特性, 逆变 (典型值), 包含 $R_{CC'+EE'}$
 $I_F=f(V_F)$

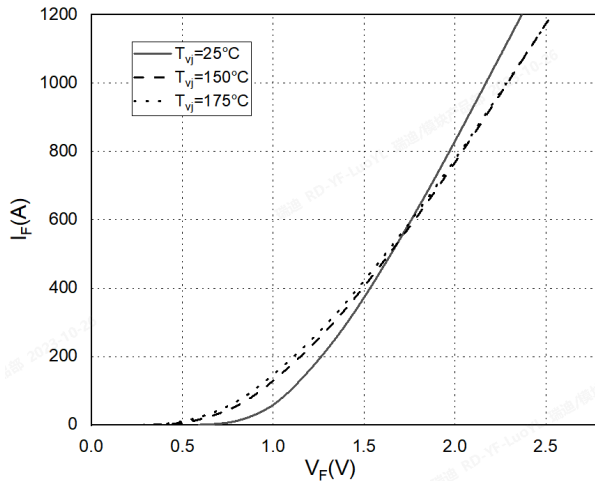

**Swiching losses FRD, Inverter (typical),
Inclusive $R_{CC}'+EE'$**

FRD 开关损耗, 逆变 (典型值), 包含 $R_{CC}'+EE'$
 $E_{rec}=f(I_F), R_{Gon}=2\Omega, V_{CE}=400V$

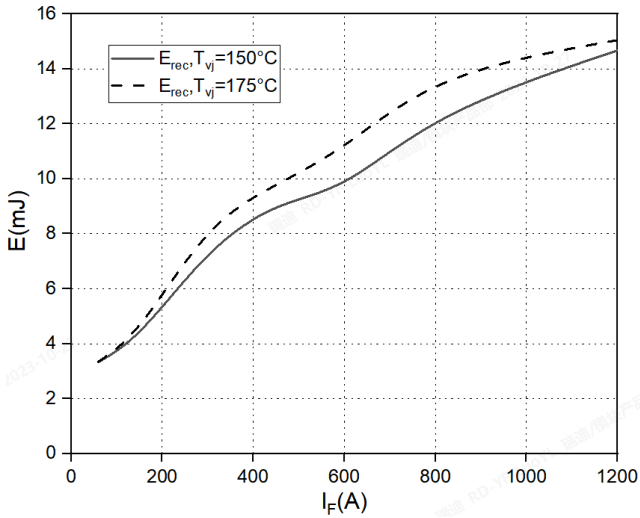

**Swiching losses FRD, Inverter (typical),
Inclusive $R_{CC}'+EE'$**

FRD 开关损耗, 逆变 (典型值), 包含 $R_{CC}'+EE'$
 $E_{rec}=f(R_G), I_F=600A, V_{CE}=400V$

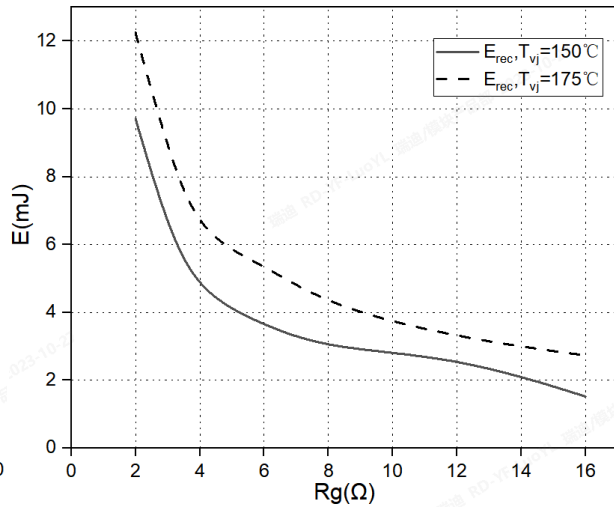

**Transient thermal impedance FRD, Inerter
FRD 瞬态热阻, 逆变**

$Z_{thJC}=f(t)$
 Cooling fluid = 50%water/50% ethylene glycol;
 $\Delta V/\Delta T=10.0dm^3/min; T_F=65^\circ C$

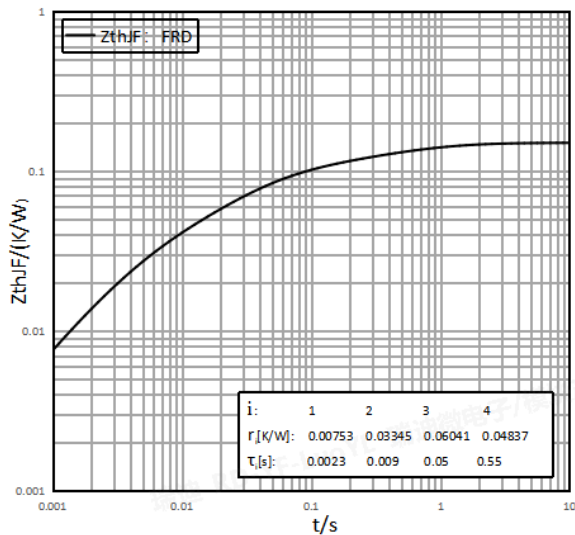

**NTC Thermistor temperature characteristic
(typical)**

NTC 热敏电阻
 $R=f(T)$

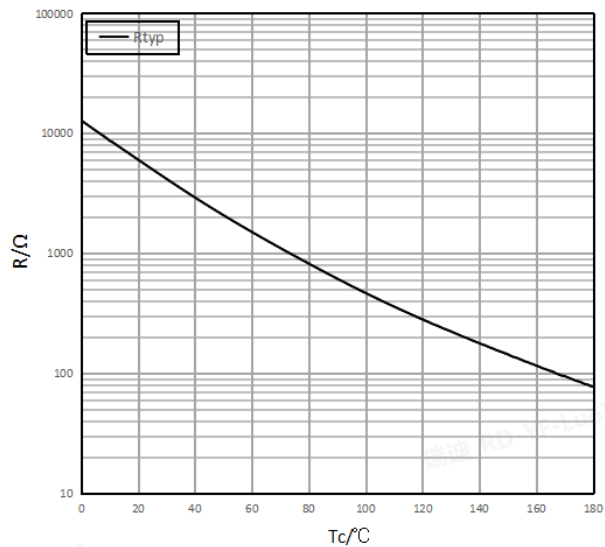

Internal Circuit / 内部电路

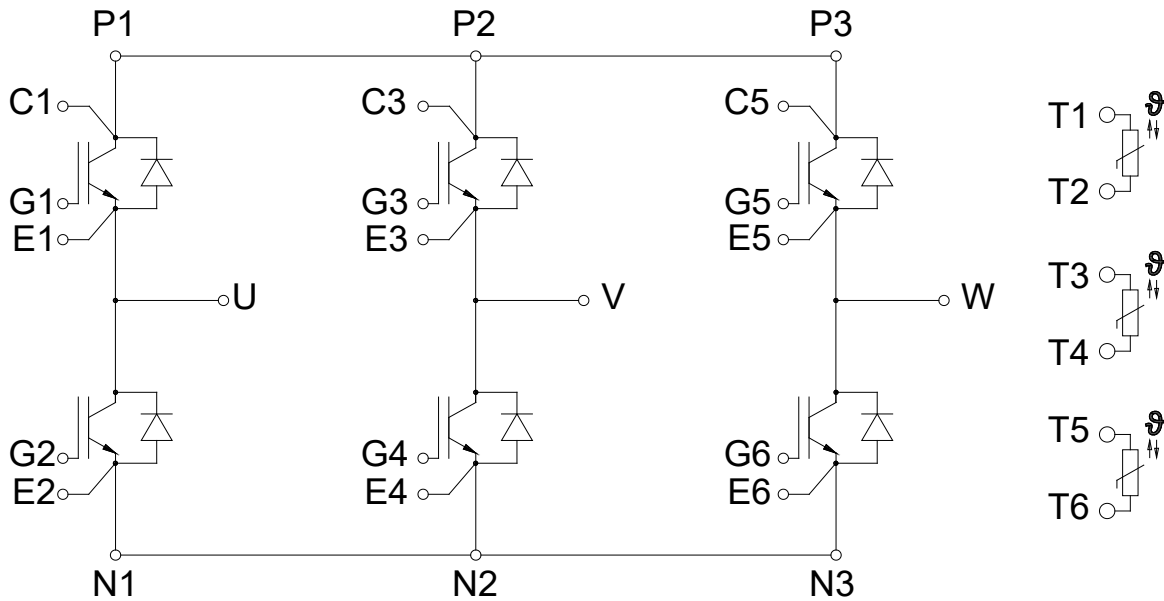

Package Dimension / 封装尺寸

Dimensions in Millimeters / 毫米为单位

